



DUROSTAMP



PRESS BRAKE TOOLING USA

DZ1DZ2-1138

OFFSET TOOLS

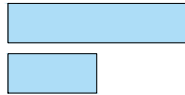

TOOLS CODE	LENGHT inch/mm	WEIGHT lb/kg
11.38.02	32.87" / 835 mm	23.15 lbs / 10.10 kg
11.38.02 - SC	16.34" / 415 mm	11.02 lbs / 5.00 kg

CODE / Z - D° - S	CODE	Z	D°	S
DZ1DZ2 - 5.0 - 90° - 1.5	11.38.02	0.197" 5,00 mm	90°	0.059" 1,50 mm

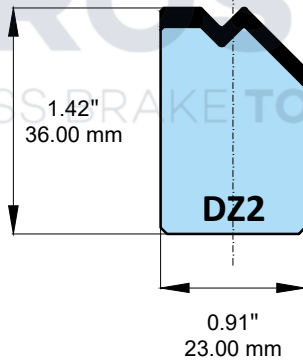
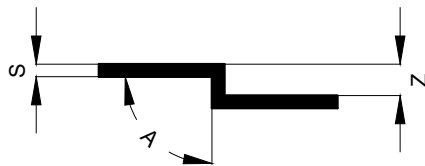

DZ SERIES
ALL STYLES

