



# DUROSTAMP



PRESS BRAKE TOOLING USA

## DZ1DZ2-1278

OFFSET TOOLS

TOOLS CODE	LENGHT inch/mm	WEIGHT lb/kg
12.78.02	32.87" / 835 mm	32.19 lbs / 14.60 kg
12.78.02 - SC	16.34" / 415 mm	16.09 lbs / 7.30 kg

CODE / Z - D° - S	CODE	Z	D°	S
DZ1DZ2 - 13.0 - 90° - 3.0	12.78.02	0.512" 13,00 mm	90°	0.118" 3,00 mm

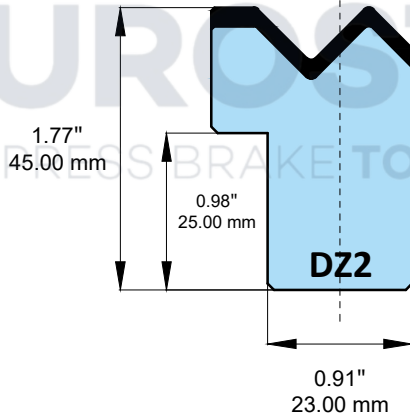
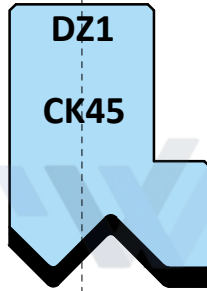
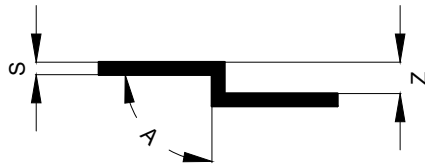

DZ SERIES  
ALL STYLES

