

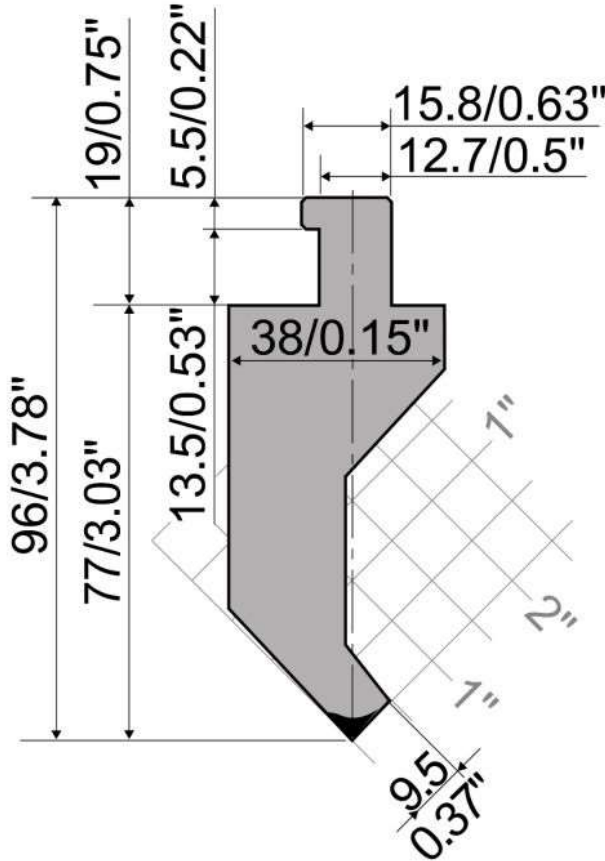

DUROSTAMP
PRESS BRAKE TOOLING USA



ASPT.77-A85°-R08



32.99"	838 mm
SC 16.34"	415 mm
SF 31.69"	805 mm
Segmented	9 Pc

28.22 lb	12.80 Kg
14.00 lb	6.35 Kg
27.12 lb	12.30 Kg
Horn Type	1X

Radius			
0.031"	0.80	mm	
42CrMo4			
22.17	T/Ft	66.00	T/M

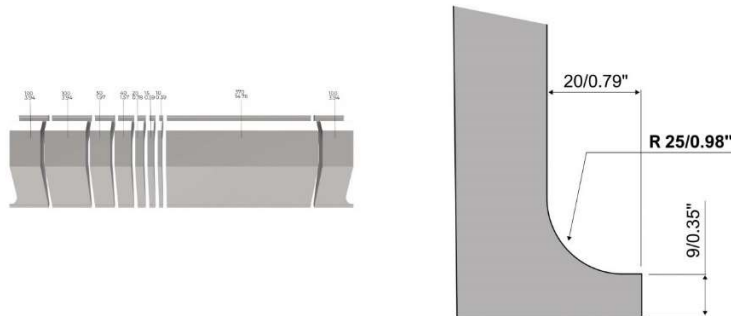

PUNCH / ASPT SERIES
AMERICAN STYLE

